

NORD-LOCK WEDGE-LOCKING SOLUTIONS

PREVENT BOLTS FROM LOOSENING



AUTHORISED DISTRIBUTOR



HOBSON ENGINEERING
10 Clay Place, Eastern Creek NSW 2766
(02) 8818 0222
www.hobson.com.au

NORD-LOCK®

WHEN SAFETY REALLY MATTERS

In the world of industry, where machinery, vehicles and equipment shape our civilization — details matter. Loosening bolts can lead to fatigue failure, unplanned downtime, production losses, significant maintenance or even injuries. Industries from oil and gas to railway, construction and power generation require a bolting solution that not only safeguard their people, projects and investments, but also equips them to go beyond the boundaries of everyday operations.

Developed in Sweden, in 1982, Nord-Lock washers prevent bolted connections from loosening — even under the most severe vibration and dynamic loads. With their unique wedge-locking technology and high-quality steel, Nord-Lock washers are the safest, most reliable bolt-securing solutions in the world.

With over 35-years of experience working under the harshest industrial conditions on earth, we have become experts at pushing the boundaries of manufacturing. From the design and production of our washers, to the rigorous testing in our technical laboratories and our personalized customer service — we will find the perfect solution for you.

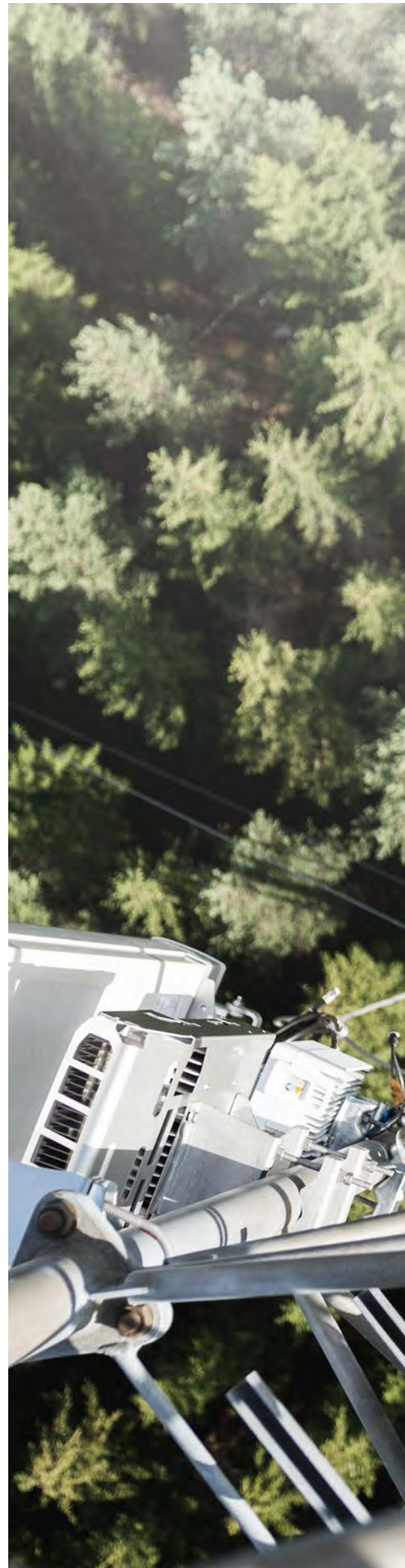



This is one of the many billions of bolts that literally hold our modern society together. Due to its design, it has an unfortunate weakness. When it is exposed to vibration it can loosen. Nord-Lock products prevent bolts from coming loose. Engineering will always challenge physical laws. For your applications and designs, Nord-Lock wedge-locking technology offers you total safety. Because just like bolted joints, vibration is everywhere.

**NO MORE
LOOSE BOLTS**

NO MORE LOOSE BOLTS

A pair of washers for maximum safety

Nord-Lock bolt securing solutions consist of a pair of washers with cams facing each other and serrations gripping the mating surfaces. They use cam-geometry to effectively prevent the bolt from vibrating loose.

Tension prevents bolts from rotating loose

Think of the bolt as a spring. Turning the fastener during tightening stretches the bolt like a spring, creating the required clamp load to hold the parts together. Nord-Lock washers secure bolted joints by increasing this clamp load if the bolt tries to rotate loose.

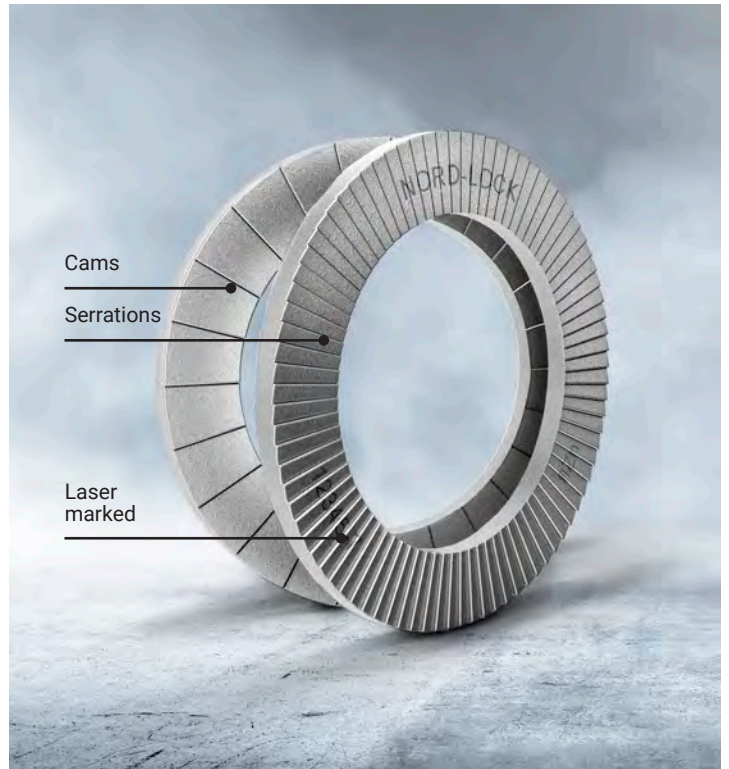

How it works

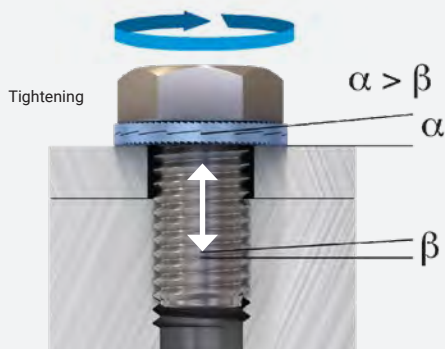

When the fastener is tightened, the cams lock and the serrations on the outer faces of the washers grip into both the fastener and the clamped part, creating clear impression marks in both. Clamping load has been created by the bolt, keeping the assembly locked in place.

Because the cam angle ' α ' is greater than the thread pitch ' β ' a wedge-locking effect secures the fastener against rotational loosening, even under the most severe conditions.

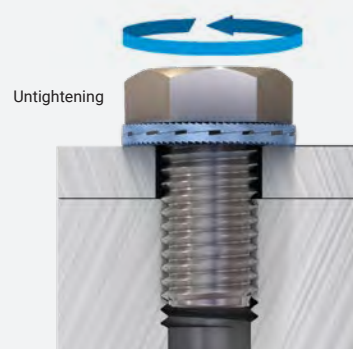

When the fastener is untightened, sliding will occur between the two washers. The upper washer is locked to the nut or bolt head by the serrations. The lower washer does not rotate as its serrations are locked into the surface being clamped.

As the cams slide over each other, the clamping load from the bolt is first increased as the bolt stretches, before being released as the cams pass each other.

AN APPROVED SOLUTION

Tested and certified

Nord-Lock washers are produced to the highest specifications and quality standards. They are rigorously tested throughout our production process and they have been approved by independent institutes as well as certification authorities. Nord-Lock washers are laser marked to ensure our customers receive genuine products and allows full traceability for every pair of washers.



Scan QR-code to watch the Junker test

High and consistent preload control

The Junker test is the most severe vibration test for bolted joints. It is used to compare how different locking methods behave under transverse vibrations between two construction parts, while continuously measuring the clamp load. Working load is normally axial, shear load is transversal load. Preload is vital to keep parts together and prevent them from sliding – when lost a bolted joint will fail.

During the Junker test (according to DIN 65151), the graph shows that the clamping load of all solutions drops dramatically apart from the Nord-Lock washers. All other solutions rely on friction, instead of geometry, to secure the bolted joint. Geometry is a more reliable locking method to control preload over time. This prevents costly downtime or potential accidents.



Watch the video! Go to www.youtube.com, search for the Nord-Lock Junker Test

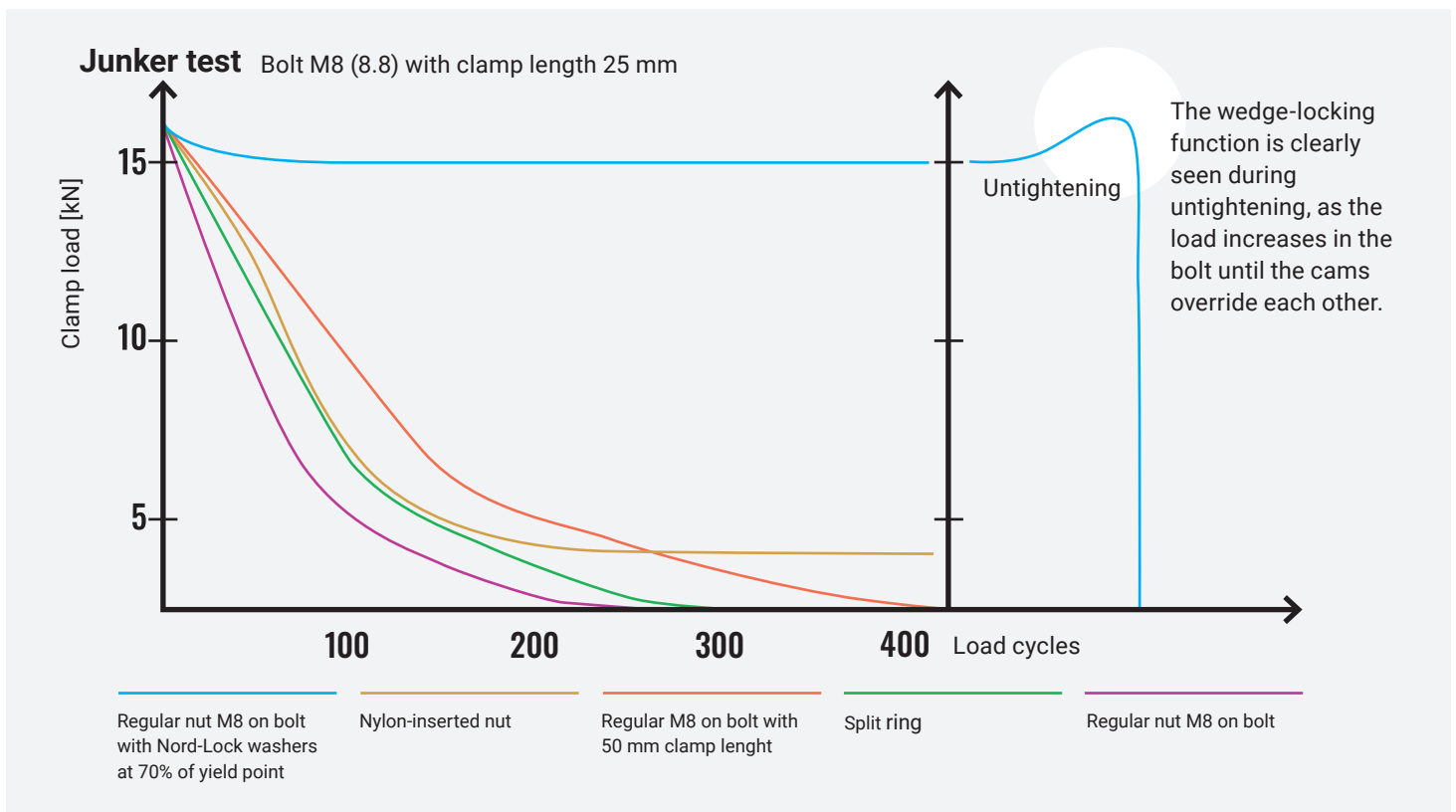

WHEN FAILURE IS NOT AN OPTION

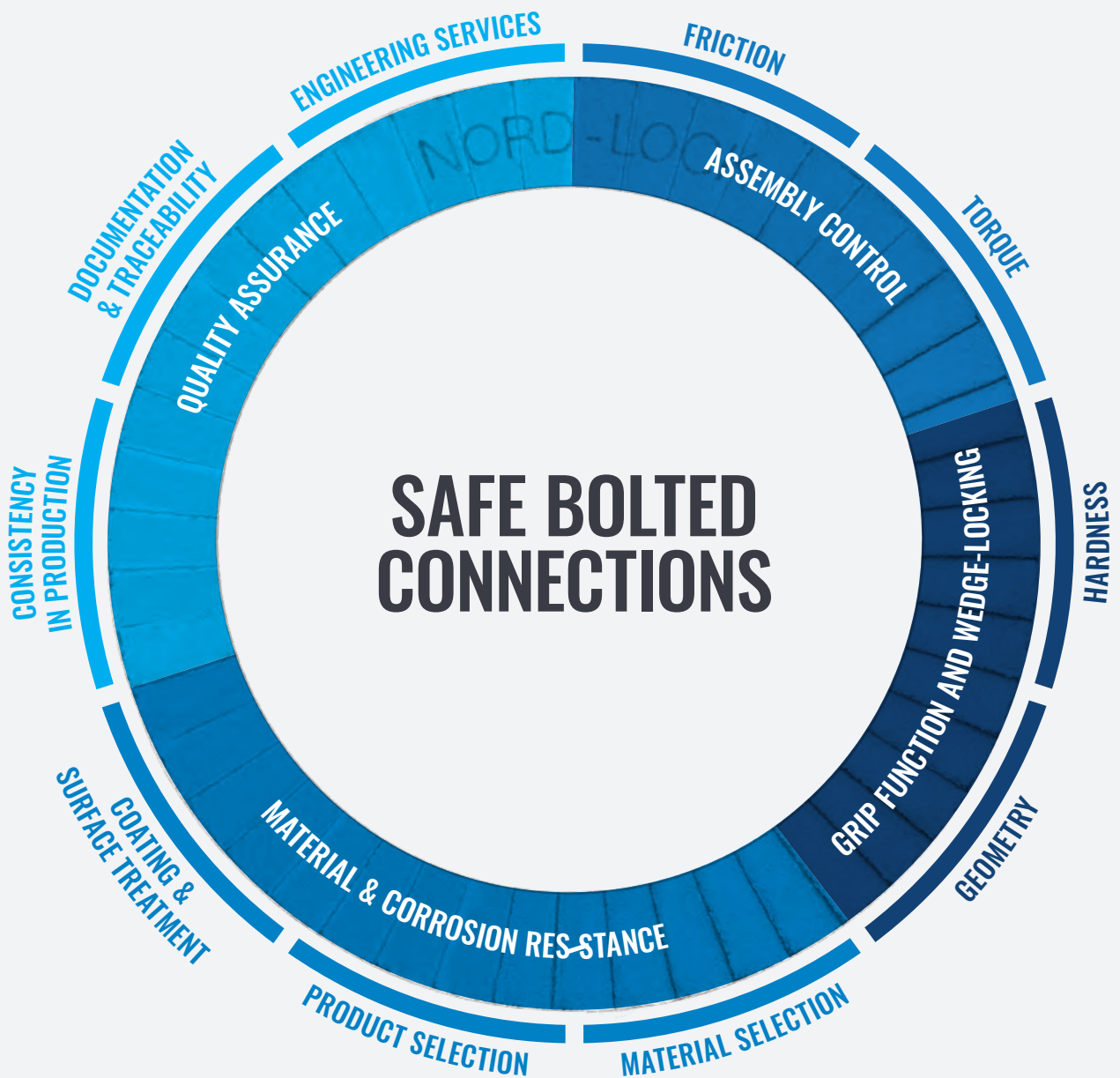



ASSEMBLY CONTROL

Preload in a bolted connection is crucial as this is what prevents parts in the assembly from opening and losing their function. Friction plays an important role in achieving the correct preload. Nord-Lock torque guidelines are based on the testing and evaluation of our products' friction value variations. Thanks to our modern in-house production, we provide consistent friction values. This ensures that you as our customer always achieve the correct preload.

GRIP FUNCTION & WEDGE-LOCKING

The wedge-locking function is activated when the two washers grip their respective mating surfaces. This ensures that movement can only occur between the washers. This is achieved by well-designed serrations and a correct hardness profile.

Our products are produced in a highly controlled environment with very tight tolerances. This ensures that each pair of washers performs equally well.

Once the assembly is tightened, the correct cam geometry effectively prevents the bolt from vibrating loose by increasing the clamping load in case rotation occurs. This is referred to as the wedge-locking effect and is what separates our washers from friction-based locking washers. Even in the most critical application, you can rely on the Nord-Lock wedge-locking technology to sustain the preload in your application.

MATERIAL & CORROSION RESISTANCE

To make every washer fulfill the demands from the bolted joint applications and the environment it operates in, our washers are based on a patented combination of high-spec materials and advanced production process. With our range of materials, designs and coating options, there is a solution for every application.

QUALITY ASSURANCE

Nord-Lock washers are produced to the very highest quality standards and are rigorously tested throughout the production process to ensure consistency and reliability. Furthermore, they have been approved by independent institutes and certification authorities. With over 35 years of experience producing wedge-locking washers, Nord-Lock guarantees a safe solution for each of your bolted connections — a pledge cemented by our lifetime warranty.

Each pair of washers is laser marked with a control number to ensure that you receive genuine products and to allow for full traceability. Nord-Lock engineering services include on-site visits by our sales engineers as well as advanced testing and verification capabilities at our state-of-the-art technical centers. If a suitable solution does not already exist, our product development team will work with you to customize a solution to suit your unique requirements.

NORD-LOCK ORIGINAL WASHERS

WIDE RANGE & MANY MATERIALS



ORIGINAL WASHERS



SP WASHERS



Nord-Lock original washers are recognized around the world for their ability to secure bolted joints exposed to severe vibration and dynamic loads. The washers increase operational reliability and lower your maintenance costs, while significantly reducing the risks of unplanned production stops, accidents and warranty claims.

Applications

Nord-Lock washers cannot loosen unintentionally as a wedge-effect is created underneath the bolt head/nut. Our extensive range includes washers in various materials and sizes.

Nord-Lock washers are available in two outer diameters – standard and enlarged. Washers with an enlarged outer diameter (SP washers) are ideal for use on large holes, sensitive surfaces and soft materials.

Nord-Lock SP washers suit flanged bolts/nuts for optimum load distribution.

Advantages

- Nord-Lock original washers secure bolted joints exposed to severe vibration and dynamic loads
- Available in a wide range of materials to suit use in general steel and stainless steel applications, and in corrosive, acidic and high-temperature environments
- Locking function not affected by lubrication
- Achieves accurate preload with defined and uniform friction
- Available in a wide range of sizes (metric and imperial)
- Designed for bolts up to and including property class 12.9 (steel) and A4-80 (stainless steel)
- High corrosion resistance (minimum 1,000 hours in salt spray test according to ISO 9227) for steel washers
- Reusable (depending on conditions of use)
- Custom sizes upon request

How it works

When a bolt is tightened, the serrations on the washers are embedded into the mating surfaces. As the cam angle ' α ' is greater than the thread pitch ' β ', a wedge-effect is created, preventing the bolt from rotating loose.

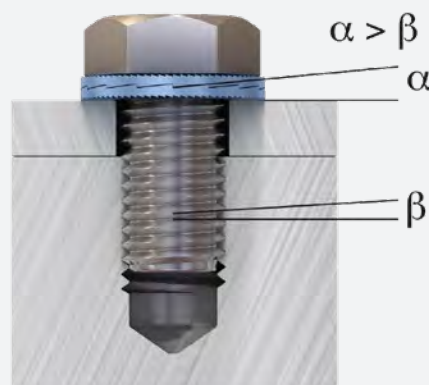

NORD-LOCK X-SERIES WASHERS

ONE SOLUTION FOR MULTIPLE
DESIGN CHALLENGES



X-SERIES WASHERS



X-SERIES SP WASHERS



Utilizing a unique multifunctional design, Nord-Lock X-series washers secure bolted joints against both spontaneous bolt loosening and slackening. Combining the unrivaled Nord-Lock wedge-effect with an exceptional spring effect, the X-series washers provide the extra level of security you need for applications that operate in extreme conditions.

Applications

Nord-Lock X-series washers are the optimum choice when you are facing extreme challenges that require extra layers of protection. Nord-Lock X-series washers keep bolted joints secure when facing multiple challenges, including:

- Material expansion and contraction during thermal cycling
- Settlements due to paint or powder-coating
- Intense vibrations on soft metals, composites and polymers
- Slackening due to multiple clamped parts
- Joints with short clamp length
- Loss of clamp load in gasketed joints

Advantages

- Secures bolted joints against loosening and compensates for loss of preload due to settlement and relaxation
- Reliable locking, even for joints with short clamp length
- Achieves accurate preload with defined and uniform friction
- Available in a wide range of sizes (metric and imperial)
- High corrosion resistance (minimum 1,000 hours in salt spray test according to ISO 9227)
- Withstands environments between -40°C and 150°C
- Designed for bolts of property class 8.8 and 10.9
- Reusable (depending on conditions of use)

How it works

Nord-Lock X-series washers combine Nord-Lock wedge-locking technology with a spring effect. The wedge effect prevents bolt loosening caused by vibration and dynamic loads. The spring effect (F_s) counteracts the slackening movement of the bolt, preventing loss of preload in the joint.

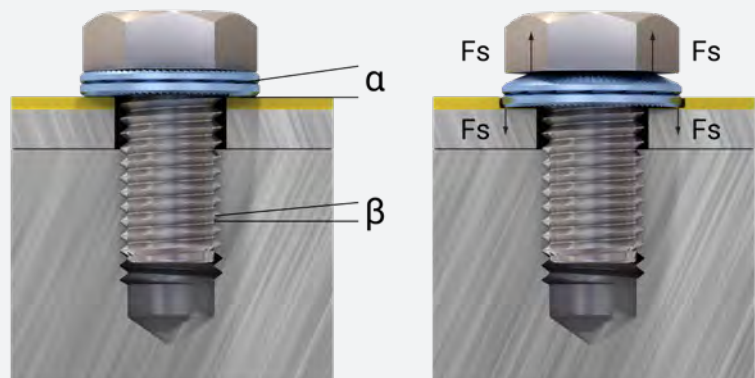

NORD-LOCK SC-WASHERS

DESIGNED FOR
STEEL CONSTRUCTION



SC-WASHERS



Nord-Lock steel construction (SC) washers are wedge-locking washers specially designed for use on steel construction applications and to fit HV/HR sets bolts and nuts in accordance to the European standard EN 14399-3/EN 14399-4/EN 14399-8.

Applications

Nord-Lock SC-washers can easily replace a standard plain washer according to EN 14399-6, to prevent the bolt from rotating loose. The SC-washers are suitable for a wide variety of applications across the construction and bridge-building industry. They are safe to use with high-strength bolts and are confirmed by the National Technical Approval No. Z-14.4-629 and the European Technical Approval ETA-20/0010 issued by DIBt.

Advantages

- Secures bolted joints in structural steelwork
- Designed and approved for use with HV sets
- Reliable locking even for joints with short clamp length
- Available in steel material with sizes from M12–M36
- High corrosion resistance (minimum 1,000 hours in salt spray test according to ISO 9227) corresponds to C4 high or C5 medium according to ISO 12944-6
- Withstand environments between -50°C and 150°C
- Locking function not affected by lubrication

How it works

The system consists of a pair of washers that use Nord-Lock wedge-locking technology. Each washer has cam faces on one side and serrations on the other. They also have chamfers on the inner diameter.

The chamfer on the inner diameter ensures optimal contact surface between the bolt and the washer. Since the chamfer is present on both sides of each pair, it also eliminates the risk of incorrect installation.

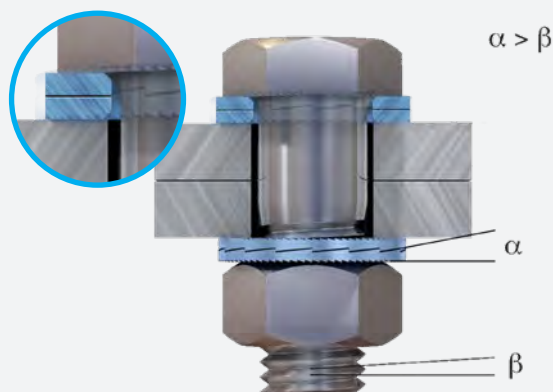

NORD-LOCK WHEEL NUTS

SAFE WHEELS
SAVE LIVES

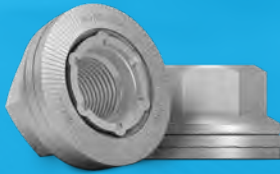

WHEEL NUTS



Nord-Lock wheel nuts safely secure wheels on commercial vehicles by maintaining a high clamp force, even under extreme operating conditions. They represent a simple and cost-effective way to make wheels safe and secure for more productive and efficient operations.

Applications

Nord-Lock wheel nuts are designed for flat-faced steel rims. Each nut is permanently attached to a pair of Nord-Lock wedge-locking washers. The wheel nut is suitable for:

- Heavy on-road vehicles (buses, trucks, trailers, etc.)
- Off-road vehicles (tractors, farming equipment, mining equipment, forestry machinery, military vehicles, etc.)

Advantages

- Improves driver productivity while reducing operating and service costs
- Minimizes risk of accidents and injury
- Suits flat-faced steel rims
- Available in sizes M16–M24
- High corrosion resistance (minimum 600 hours in salt spray test according to ISO 9227)
- Reusable (depending on conditions of use)

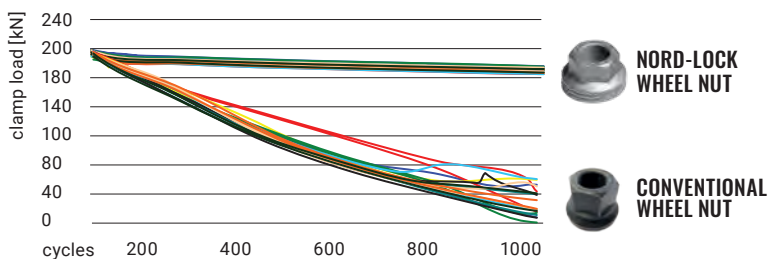

**NORD-LOCK
WHEEL NUT**

**CONVENTIONAL
WHEEL NUT**

The Nord-Lock wheel nut safely secured the wheel joint and maintained the clamp load. Only initial settlements were indicated in the graphs.

The graphs display products tightened to 200 kN and the change in clamp load during 1000 load cycles.

How it works

When the Nord-Lock wheel nut is tightened, the serrations on the washers are embedded into the mating surfaces, allowing movement only across the cam faces. Any rotation of the wheel nut is prevented by the wedge-effect of the cams.

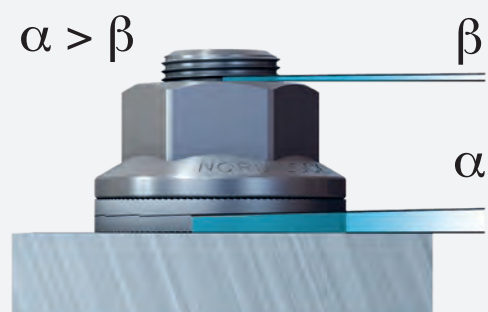

CONSISTENCY IS WHAT SETS OUR WASHERS APART

Our attention to detail ensures the products you receive are consistently excellent, so you can expect exceptional performance with every use.



WHEN YOU'RE MOVING AT 320 KM/H,
WE WON'T MOVE AT ALL



Fast delivery

We ship our standard range of washers globally. Nord-Lock products are supplied through distribution centers in North America, Europe and Asia, ensuring that they are available anytime, anywhere.

Traceability

All Nord-Lock washers are laser marked with the Nord-Lock brand name, control number and a type code. This ensures that all our customers receive genuine washers and allows full traceability down to the raw material charge at the steel mill. Nord-Lock washers are rigorously tested under extreme conditions and approved by independent institutes and certification authorities to ensure total alignment with quality requirements.

The industry's first full Lifetime Warranty

You can trust our products, which is why we introduced the industry's first full lifetime warranty. This guarantees that our washers will stay in place and fulfill their function for the entire lifetime of the bolted connection.

Quality and environmental assurance

Nord-Lock washers are high end products with documented success in many industries. Our washers are approved by several industry standards and specified by numerous international companies.

- ISO 9001:2015
- ISO 14001:2015
- RoHS, ELV and Reach compliant



Certificates and approvals

- DIBt (Deutsches Institut für Bautechnik)
- DNV GL (Det Norske Veritas Germanischer Lloyd)
- EBA (Eisenbahn-Bundesamt)
- TÜV (Technischer Überwachungs-Verein)
- LR (Lloyd's Register)

For more information or a complete list of certificates and approvals, please visit nord-lock.com or contact your nearest Nord-Lock representative.

YOUR PARTNER IN SECURE BOLTING SOLUTIONS

At Nord-Lock, we understand that your projects are bigger than a single product, which is why we offer you a range of technical expertise and services to make your job easier. Whatever your challenge, our in-house experts will combine their product and industry knowledge to offer you a bolting solution that is quick and easy to install, without the need for frequent checks and retightening.

WE WORK CLOSELY WITH YOU

Analysis

Our highly specialized application engineers can perform bolted joint calculations and verifications – including Finite Element Method, macro and microscopic analysis, VDI 2230:2015 calculation, NF E 25030-1 and -2, ASME code, RCC-M code and more.

Tests

Our technical centers are equipped with state-of-the-art testing equipment. These are at your disposal for Junker tests according to DIN 65151, DIN 25201-4 and ISO 16130, torque-tensile tests, joint failure analysis and more.

Engineering Expertise

Our engineers can help you solve your bolting challenges to improve safety and reduce costs. We provide training, offer installation support and even customized technical guidelines.





MORE SUPPORT FOR YOU

- On-site training

We share our knowledge and experience of best bolting practices with your team.

- E-learning

Courses are available for anyone working with Nord-Lock washers. Courses cover general bolting knowledge as well as in-depth technical information about our products.

- Technical centers and seminars

You are welcome to visit our offices and technical centers for a tour, or to attend seminars about bolted joints. For more information contact your local Nord-Lock representative.

- Technical guides, user manuals and CAD files

We provide supporting materials such as technical guides, user manuals and CAD files to help you use our products. If you are looking for custom materials, please contact your local Nord-Lock representative.
www.nord-lock.com/download
www.nord-lock.com/cad

2D/3D CAD models



Torque guidelines



- Fastener Dimension Guide

Gather fastener data while performing bolted joint calculations. Enter the size and length of a bolt and find all the dimensions that conform to ISO standards.

Use the app at

fastener-standards.nord-lock.com

The Fastener Dimension Guide was developed by Nord-Lock Group in cooperation with the Swedish Standards Institute (SIS).

- Torquelator by Nord-Lock

Calculate the required preload and corresponding torque of Nord-Lock washers quickly, easily and accurately.

Use the app at

torquelator.nord-lock.com

For help with more complex torque calculations, contact your nearest Nord-Lock representative.

THE WORLD'S TOUGHEST WORKING ENVIRONMENTS

WE'LL WORK THERE WITH YOU

Our wedge-locking solutions are used all over the world, from the deepest subsea situations to power stations, bridges and wind turbines. No matter where you are or what you are working on, we will be there to help you ensure safer, more efficient operations.

POWER GENERATION

Nord-Lock washers are used for their quick and easy installation process, as well as their ability to protect bolted joints from loosening and fatigue failure. The Nord-Lock range contributes to low lifecycle costs and increased uptime by optimizing maintenance routines.

Applications

- Wind turbines: transmission parts, blades, generator, nacelle, platforms, ladders
- Nuclear installations: pumps, valves, filters, earthquake-proof equipment
- Main coupling
- Compressor to combustion casing
- Vertical split-line
- Turbine casing half joint
- Foundation bolts
- Combustors and fuel nozzles
- Exhaust transition ducts
- Slewing ring

BRIDGE BUILDING & CONSTRUCTION

Long bridges, tall skyscrapers and tunnels deep beneath the ground all have countless joints where accessibility is difficult, but security is vital for safety and functionality.

There are many large and powerful machines on construction sites such as excavators, cranes and drills, where bolted joints are subjected to vibration and dynamic loads. There is also equipment and materials, all of which need to ensure a construction site is safe, productivity is high, and that the final result is strong and durable.

For infrastructure investments with high life expectancy, Nord-Lock offers safe and durable bolting.

Additionally, as an industry leader in secure bolting, we have the engineering skills needed to secure innovative solutions in construction design.

Applications

- Steel construction: crane runway conveying systems, dedusting system for steel chimney, substructures of storage racks
- Bridges: steel beam sleepers
- Towers and tunnels: revolving doors

RAILWAY

Trains need to be reliable and they need to be on time. Bolt loosening anywhere on railway infrastructure and rolling stock can be costly, and even fatal if a train is in motion.

With hundreds of thousands of kilometers of tracks covering the earth's surface, along with numerous types of switches, checking and re-tightening bolted joints is time consuming and costly work. Bolt security is essential for safety and Nord-Lock washers are used within the railway industry for their proven quality and reliability.

Rolling stock

Bogie

- Bogie skirts
- Axle boxes and covers
- Brake calipers
- Suspension parts
- Generators

Interior

- Auto door systems
- Handrails
- Passenger seats

Exterior

- Underfloor equipment
- Pantographs
- Connecting parts

Infrastructure

Track

- Switches
- Rail fastenings
- Fish plates assembly
- Sound absorbers
- Sensors

Construction

- Signage fasteners
- Noise barrier
- Bridge construction

Signal/Crossing

- Signals
- Crossing barriers
- Gantries



MANUFACTURING & PROCESSING

One thing all manufacturing and processing equipment shares is the need to be in constant motion. One fault or breakdown can cease productivity for the whole line, and every minute of downtime is costly. This is especially true for bolted joints as wear or loosening can come at a significant cost.

Applications

- Cable jacks
- Valves
- Gear boxes
- Connectors
- Pumps
- Rotators
- Sensors

TRANSPORT

Many modes of transport operate in extreme conditions and temperatures, and are subjected to dynamic loads and constant vibration. Safety is largely dependent on everything staying together, and that in turn relies on safe, secure fasteners that can withstand all demands.

Applications

- Suspension units
- Steering components
- Brakes
- Body and chassis mounting points
- Engine ancillaries
- Turbo charger and exhaust systems
- Gearbox / driveline
- Door systems
- Tank containers on trucks
- Securing wheels on trucks, buses, agriculture vehicles with Nord-Lock wheel nuts



OIL & GAS

Working on an oil rig is tough. Strong winds and rain threaten to pull you over the edge and you are deafened by the sound of heavy machinery. Drilling operations expose you to the risk of serious injury, making safety absolutely paramount. Equipment is in constant operation and everything needs to be 100 percent reliable. The pace needs to be high and every minute of downtime is costly.

Our washers let you tighten and loosen bolts quickly, easily and safely – even when you are working in the harshest environments.



Applications

- Launch and recovery system (LARS) for ROV (Remotely Operated Vehicles) on vessel
- Structural steelwork (incl. derricks)
- Pipe handling equipment
- Blow Out Preventers
- Gas turbine exhaust ducts
- Pumps & valves
- Walkway, ladders and handrails
- Top side (platform): various applications such as windwalls, pipe supports, cable trays
- Flame tower
- Cranes
- Fingerboard
- Subsea pipeline plough
- Subsea tree

MINING & MINERALS

Mines and quarries are riddled with large, heavy-duty machines built specifically for crushing and drilling through solid rock. These machines are subjected to the most demanding conditions, from extreme loads to constant vibration.

But for all their strength and durability, it can often be the smaller bolted joints that buckle first, and therefore bolt security cannot be compromised. Solutions from Nord-Lock are suitable for the most critical and exposed joints.

Applications

- Rock drilling
- Crushing
- Screening
- Hydraulic hammers
- Tunnel and shaft boring
- Slurry pumps
- Trucks



SAFEGUARDING HUMAN LIVES AND CUSTOMER INVESTMENTS

NORD-LOCK GROUP

In 1982, Nord-Lock developed the original wedge-locking technology that secures bolted joints. Since then, the company has grown to include a range of cutting-edge bolting technologies that together, provide the most comprehensive bolting solutions on the market.

Owned by Swedish investment group Latour, Nord-Lock Group is a global partner for all industries. We are present in 65 countries, with six production plants and six technical facilities around the world.

Nord-Lock Group is on a mission to make the world a safer place and help our customers go beyond what's possible. With a unique combination of bolting expertise and a comprehensive product range, we will provide you with the best solution for your bolting challenge.

NORD-LOCK

Creator of the original wedge-locking washer technology and global leader in industrial washer solutions.

SUPERBOLT

Inventor of the patented Superbolt multi-jackbolt tensioners, designed to eliminate unsafe bolting methods.

BOLTIGHT

Pioneer in innovative hydraulic bolt tensioning, specializing in extreme environments.

Expander

Leader in pivot pin technology, on a mission to end lug wear on industrial sites everywhere.



65+
COUNTRIES

25+
OFFICES
WORLDWIDE

500+
EMPLOYEES

6
PRODUCTION
PLANTS

6
TECHNICAL
CENTERS

NORD-LOCK ORIGINAL WASHERS

PRODUCT SELECTION

Nord-Lock offers products in a wide range of sizes, shapes and materials. They are developed to suit even the toughest environments. If you need support selecting the most appropriate product, please contact your closest Nord-Lock sales representative.



STEEL



STAINLESS STEEL

* Washer hardness must be greater than the hardness of the mating surfaces in order to assure its mechanical function.

** Corrosion resistance is known as PREN. PREN, or Pitting Resistance Equivalent Number, is a theoretical number calculated from the chemical composition of the raw material. The formula is: $PREN = \%Cr + 3.3x\%Mo + 16x\%N$.

*** Temperature recommendations are based on information from the raw material supplier and testing. The locking function is not affected within the specified range.

	STEEL	STAINLESS STEEL
Applications	General steel application	General stainless steel application
Material Standard	EN 1.7182	EN 1.4404
Hardening	Through hardened	Surface hardened
Hardness*	≥ 465HV1	≥ 520HV0.05
Corrosion Resistance**	Minimum 1,000 hours in salt spray test according to ISO 9227	PREN 27
Temperature Range***	-50°C to 200°C	-160°C to 500°C
Bolt Grades	Up to 12.9	Up to A4-80
Product Designation	NL NLsp	NLss NLspss
Laser Marking Type Code	flZn	SS
Size Range	M3–M130 #5 to 5"	M3–M80 #5 to 3 1/8"
Coating	Base coat: Delta Protekt® KL100 zinc flake coating Top coat: VH 302 GZ	—

254 SMO®**ALLOY C-276****ALLOY 718**

Applications	Corrosive environment – chloride rich environments, pumps, heat exchangers, nuclear, food, medical, processing	Acidic environment – chemical industry, evaporators, offshore, downhole tooling	High temperatures – gas turbines, turbo charges, incinerators
Material Standard	EN 1.4547	EN 2.4819 or equivalent	EN 2.4668 or equivalent
Hardening	Surface hardened	Surface hardened	Surface hardened
Hardness*	≥ 600HV0.05	≥ 520HV0.05	≥ 620HV0.05
Corrosion Resistance**	PREN 45	PREN 68	PREN 29
Temperature Range***	-160°C to 500°C	-160°C to 500°C	-160°C to 700°C
Bolt Grades	Up to A4-80	–	–
Product Designation	NLss-254 NLspss-254	NLss-276 NLspss-276	NLss-718 NLspss-718
Laser Marking Type Code	254	276	718
Size Range	M3–M39 #5 to 1 1/2"	M4–M20 #5 to 1 1/2"	M4–M20 #5 to 1 1/2"
Coating	–	–	–

STEEL ORIGINAL WASHERS

DIMENSIONS

Delta Protekt® Zinc Flake Coating

Through hardened EN 1.7182

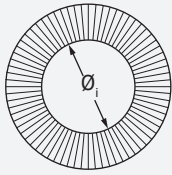

NL3-NL8sp
Ø_i±0.1 mm
NL3/8"-NL42
Ø_i±0.2 mm
NL45-NL130
Ø_i+0.5 / -0.0 mm

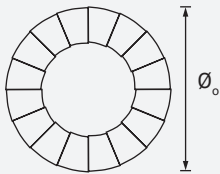

NL3-NL1"sp
Ø_o±0.2 mm
NL27-NL42
Ø_o±0.3 mm
NL45-NL130
Ø_o+0.0 / -2.0 mm

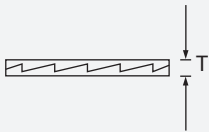

NL3-NL42
T±0.25 mm
NL45-NL130
T±0.75 mm

Note that washers with thickness 6.6 mm have a thickness tolerance +0.0 / -0.5 mm

Nord-Lock steel washers in sizes NL3-NL52 with zinc flake coating are standard stock items.

Torque guidelines



2D/3D CAD models



- Torque guidelines:
Web app: torquelator.nord-lock.com
www.nord-lock.com/torque

- 2D/3D CAD models:
www.nord-lock.com/cad

Bolt size	Metric	UNC	Product designation	Ø _i [mm]	Ø _o [mm]	Thickness T [mm]	Approx. weight kg/100 pairs	Min. Package [pairs]
M3	#5		NL3	3.4	7.0	1.8	0.03	200
M3.5	#6		NL3.5	3.9	7.6	1.8	0.04	200
M3.5	#6		NL3.5sp	3.9	9.0	1.8	0.06	200
M4	#8		NL4	4.4	7.6	1.8	0.04	200
M4	#8		NL4sp	4.4	9.0	1.8	0.06	200
M5	#10		NL5	5.4	9.0	1.8	0.05	200
M5	#10		NL5sp	5.4	10.8	1.8	0.11	200
M6			NL6	6.5	10.8	1.8	0.07	200
M6			NL6sp	6.5	13.5	2.5	0.20	200
		1/4"	NL1/4"	7.2	11.5	2.5	0.08	200
		1/4"	NL1/4"sp	7.2	13.5	2.5	0.18	200
M8	5/16"		NL8	8.7	13.5	2.5	0.15	200
M8	5/16"		NL8sp	8.7	16.6	2.5	0.28	200
		3/8"	NL3/8"	10.3	16.6	2.5	0.23	200
		3/8"	NL3/8"sp	10.3	21.0	2.5	0.48	200
M10			NL10	10.7	16.6	2.5	0.22	200
M10			NL10sp	10.7	21.0	2.5	0.47	200
M11	7/16"		NL11	11.4	18.5	2.5	0.29	200
M12			NL12	13.0	19.5	2.5	0.29	200
M12			NL12sp	13.0	25.4	3.4	0.93	100
		1/2"	NL1/2"	13.5	19.5	2.5	0.27	200
		1/2"	NL1/2"sp	13.5	25.4	3.4	0.90	100
M14	9/16"		NL14	15.2	23.0	3.4	0.56	100
M14	9/16"		NL14sp	15.2	30.7	3.4	1.41	100
M16	5/8"		NL16	17.0	25.4	3.4	0.67	100
M16	5/8"		NL16sp	17.0	30.7	3.4	1.28	100
M18			NL18	19.5	29.0	3.4	0.89	100
M18			NL18sp	19.5	34.5	3.4	1.58	100
		3/4"	NL3/4"	20.0	30.7	3.4	1.05	100
		3/4"	NL3/4"sp	20.0	39.0	3.4	2.21	100
M20			NL20	21.4	30.7	3.4	0.93	100
M20			NL20sp	21.4	39.0	3.4	2.09	100
M22	7/8"		NL22	23.4	34.5	3.4	1.25	100
M22	7/8"		NL22sp	23.4	42.0	4.6	3.19	50
M24			NL24	25.3	39.0	3.4	1.74	100
M24			NL24sp	25.3	48.5	4.6	4.51	50
		1"	NL1"	27.9	39.0	3.4	1.53	100
		1"	NL1"sp	27.9	48.5	4.6	4.20	50
M27			NL27	28.4	42.0	5.8	3.14	50
M27			NL27sp	28.4	48.5	5.8	5.27	25
M30	1 1/8"		NL30	31.4	47.0	5.8	4.10	50
M30	1 1/8"		NL30sp	31.4	55.0	5.8	7.00	25
M33	1 1/4"		NL33	34.4	48.5	5.8	3.89	25
M33	1 1/4"		NL33sp	34.4	58.5	5.8	8.00	25
M36	1 3/8"		NL36	37.4	55.0	5.8	5.49	25
M36	1 3/8"		NL36sp	37.4	63.0	5.8	8.58	25
M39	1 1/2"		NL39	40.4	58.5	5.8	5.89	25
M42			NL42	43.2	63.0	5.8	7.97	25
M45	1 3/4"		NL45	46.2	70.0	7.0	10.20	25
M48			NL48	49.6	75.0	7.0	12.00	25
M52	2"		NL52	53.6	80.0	7.0	13.00	25
M56	2 1/4"		NL56	59.1	85.0	7.0	13.50	10
M60			NL60	63.1	90.0	7.0	15.20	10
M64	2 1/2"		NL64	67.1	95.0	7.0	16.70	10
M68			NL68	71.1	100.0	9.5	28.20	1
M72			NL72	75.1	105.0	9.5	30.70	1
M76	3"		NL76	79.1	110.0	9.5	33.30	1
M80	3 1/8"		NL80	83.1	115.0	9.5	36.00	1
M85			NL85	88.1	120.0	9.5	37.80	1
M90			NL90	92.4	130.0	9.5	47.70	1
M95			NL95	97.4	135.0	9.5	49.80	1
M100	4"		NL100	103.4	145.0	9.5	58.90	1
M105			NL105	108.4	150.0	9.5	61.30	1
M110			NL110	113.4	155.0	9.5	63.50	1
M115			NL115	118.4	165.0	9.5	75.30	1
M120			NL120	123.4	170.0	9.5	77.90	1
M125			NL125	128.4	173.0	9.5	76.60	1
M130	5"		NL130	133.4	178.0	9.5	79.20	1

STAINLESS STEEL ORIGINAL WASHERS

DIMENSIONS

Surface hardened EN 1.4404
(AISI 316L)

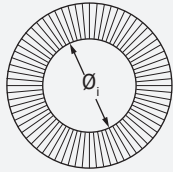

NL3ss-NL8spss
 $\text{Ø}_i \pm 0.1 \text{ mm}$
NL3/8"ss-NL42ss
 $\text{Ø}_i \pm 0.2 \text{ mm}$
NL45ss-NL80ss
 $\text{Ø}_i +0.5 / -0.0 \text{ mm}$

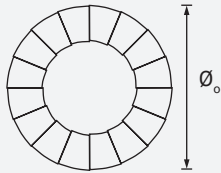

NL3ss-NL1"spss
 $\text{Ø}_o \pm 0.2 \text{ mm}$
NL27ss-NL42ss
 $\text{Ø}_o \pm 0.3 \text{ mm}$
NL45ss-NL80ss
 $\text{Ø}_o +0.0 / -2.0 \text{ mm}$

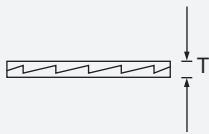

NL3ss-NL1"spss
 $T \pm 0.25 \text{ mm}$
NL27ss-NL42ss
 $T +0.0 / -0.5 \text{ mm}$
NL45ss-NL80ss
 $T \pm 0.75 \text{ mm}$

EN 1.4404 is an austenitic chromium-nickel stainless steel containing molybdenum. EN 1.4404 is one of the most commonly used stainless steel grades. This stainless steel also has extra-low carbon content in order to reduce the risk of chromium-carbide precipitation.

Nord-Lock washers made of EN 1.4404 are suitable for most applications where no chlorides or acids are present.

Nord-Lock washers made of stainless steel are standard stock items, yet subject to prior sale.

- Torque guidelines:

Web app: torquelator.nord-lock.com
www.nord-lock.com/torque

- 2D/3D CAD models:

www.nord-lock.com/cad

Bolt size		Product designation	Ø_i	Ø_o	Thickness T	Approx. weight	Min. Package
Metric	UNC		[mm]	[mm]	[mm]	kg/100 pairs	[pairs]
M3	#5	NL3ss	3.4	7.0	2.2	0.04	200
M3.5	#6	NL3.5ss	3.9	7.6	2.2	0.04	200
M3.5	#6	NL3.5spss	3.9	9.0	2.2	0.07	200
M4	#8	NL4ss	4.4	7.6	2.2	0.04	200
M4	#8	NL4spss	4.4	9.0	2.2	0.07	200
M5	#10	NL5ss	5.4	9.0	2.2	0.06	200
M5	#10	NL5spss	5.4	10.8	2.2	0.11	200
M6		NL6ss	6.5	10.8	2.2	0.09	200
M6		NL6spss	6.5	13.5	2.0	0.16	200
	1/4"	NL1/4"ss	7.2	11.5	2.2	0.09	200
	1/4"	NL1/4"spss	7.2	13.5	2.2	0.15	200
M8	5/16"	NL8ss	8.7	13.5	2.0	0.12	200
M8	5/16"	NL8spss	8.7	16.6	2.0	0.23	200
	3/8"	NL3/8"ss	10.3	16.6	2.0	0.19	200
	3/8"	NL3/8"spss	10.3	21.0	2.0	0.38	200
M10		NL10ss	10.7	16.6	2.0	0.18	200
M10		NL10spss	10.7	21.0	2.0	0.37	200
M11	7/16"	NL11ss	11.4	18.5	2.2	0.26	200
M12		NL12ss	13.0	19.5	2.0	0.23	200
M12		NL12spss	13.0	25.4	3.0	0.82	100
	1/2"	NL1/2"ss	13.5	19.5	2.0	0.22	200
	1/2"	NL1/2"spss	13.5	25.4	3.2	0.80	100
M14	9/16"	NL14ss	15.2	23.0	3.0	0.49	100
M14	9/16"	NL14spss	15.2	30.7	3.2	1.31	100
M16	5/8"	NL16ss	17.0	25.4	3.0	0.59	100
M16	5/8"	NL16spss	17.0	30.7	3.2	1.13	100
M18		NL18ss	19.5	29.0	3.2	0.80	100
M18		NL18spss	19.5	34.5	3.2	1.56	100
	3/4"	NL3/4"ss	20.0	30.7	3.2	0.96	100
	3/4"	NL3/4"spss	20.0	39.0	3.2	2.10	100
M20		NL20ss	21.4	30.7	3.0	0.82	100
M20		NL20spss	21.4	39.0	3.2	2.06	100
M22	7/8"	NL22ss	23.4	34.5	3.2	1.23	100
M22	7/8"	NL22spss	23.4	42.0	3.2	2.22	50
M24		NL24ss	25.3	39.0	3.2	1.59	100
M24		NL24spss	25.3	48.5	4.5	4.47	50
	1"	NL1"ss	27.9	39.0	3.2	1.42	100
	1"	NL1"spss	27.9	48.5	3.2	2.79	50
M27		NL27ss	28.4	42.0	6.8	3.45	50
M27		NL27spss	28.4	48.5	6.8	5.34	25
M30	1 1/8"	NL30ss	31.4	47.0	6.8	4.49	50
M30	1 1/8"	NL30spss	31.4	58.5	6.8	9.18	25
M33	1 1/4"	NL33ss	34.4	48.5	6.8	4.28	25
M36	1 3/8"	NL36ss	37.4	55.0	6.8	5.96	25
M39	1 1/2"	NL39ss	40.4	58.5	6.8	6.74	25
M42		NL42ss	43.2	63.0	6.8	7.50	25
M45	1 3/4"	NL45ss	46.2	70.0	6.8	10.20	25
M48		NL48ss	49.6	75.0	6.8	12.00	25
M52	2"	NL52ss	53.6	80.0	9.0	18.04	1
M56	2 1/4"	NL56ss	59.1	85.0	9.0	21.30	1
M60		NL60ss	63.1	90.0	9.0	23.50	1
M64	2 1/2"	NL64ss	67.1	95.0	9.0	25.80	1
M68		NL68ss	71.1	100.0	9.0	28.20	1
M72		NL72ss	75.1	105.0	9.0	30.70	1
M76	3"	NL76ss	79.1	110.0	9.0	33.30	1
M80	3 1/8"	NL80ss	83.1	115.0	9.0	36.00	1

254 SMO® ORIGINAL WASHERS

DIMENSIONS

Surface hardened EN 1.4547

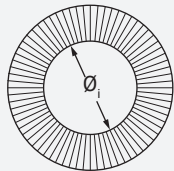

NL3ss-254
-NL8spss-254
Ø_i ±0.1 mm
NL3/8"ss-254
-NL39ss-254
Ø_i ±0.2 mm

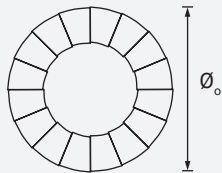

NL3ss-254
-NL1"spss-254
Ø_o ±0.2 mm
NL27ss-254
-NL39ss-254
Ø_o ±0.3 mm

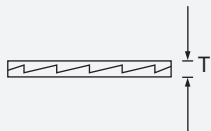

NL3ss-254
-NL39ss-254
T ±0.25 mm

254 SMO® is an austenitic stainless steel designed for maximum resistance to pitting and crevice corrosion. With high levels of chromium, molybdenum, and nitrogen, washers made from 254 SMO® are especially suited for:

- High chloride environments
- Salt water solutions/atmospheres
- Environments where stainless steel washers made of 1.4404 are not adequate

Nord-Lock washers made of 254 SMO® quality are standard stock items, yet subject to prior sale.

- Torque guidelines:

Web app: torquelator.nord-lock.com
www.nord-lock.com/torque

- 2D/3D CAD models:

www.nord-lock.com/cad

Bolt size		Product designation	Ø _i [mm]	Ø _o [mm]	Thickness T [mm]	Approx. weight kg/100 pairs	Min. package [pairs]
Metric	UNC						
M3	#5	NL3ss-254	3.4	7.0	2.2	0.04	200
M3.5	#6	NL3.5ss-254	3.9	7.6	2.2	0.04	200
M3.5	#6	NL3.5spss-254	3.9	9.0	2.2	0.07	200
M4	#8	NL4ss-254	4.4	7.6	2.2	0.04	200
M4	#8	NL4spss-254	4.4	9.0	2.2	0.07	200
M5	#10	NL5ss-254	5.4	9.0	2.2	0.06	200
M5	#10	NL5spss-254	5.4	10.8	2.2	0.11	200
M6		NL6ss-254	6.5	10.8	2.2	0.09	200
M6		NL6spss-254	6.5	13.5	2.0	0.16	200
	1/4"	NL1/4"ss-254	7.2	11.5	2.2	0.09	200
	1/4"	NL1/4"spss-254	7.2	13.5	2.2	0.15	200
M8	5/16"	NL8ss-254	8.7	13.5	2.0	0.12	200
M8	5/16"	NL8spss-254	8.7	16.6	2.2	0.22	200
	3/8"	NL3/8"ss-254	10.3	16.6	2.0	0.19	200
	3/8"	NL3/8"spss-254	10.3	21.0	2.2	0.38	200
M10		NL10ss-254	10.7	16.6	2.0	0.18	200
M10		NL10spss-254	10.7	21.0	2.2	0.37	200
M11	7/16"	NL11ss-254	11.4	18.5	2.2	0.26	200
M12		NL12ss-254	13.0	19.5	2.0	0.23	200
M12		NL12spss-254	13.0	25.4	3.2	0.83	100
	1/2"	NL1/2"ss-254	13.5	19.5	2.0	0.23	200
	1/2"	NL1/2"spss-254	13.5	25.4	3.2	0.80	100
M14	9/16"	NL14ss-254	15.2	23.0	3.0	0.49	100
M14	9/16"	NL14spss-254	15.2	30.7	3.2	1.13	100
M16	5/8"	NL16ss-254	17.0	25.4	3.0	0.59	100
M16	5/8"	NL16spss-254	17.0	30.7	3.2	1.13	100
M18		NL18ss-254	19.5	29.0	3.2	0.80	100
M18		NL18spss-254	19.5	34.5	3.2	1.56	100
	3/4"	NL3/4"ss-254	20.0	30.7	3.2	0.96	100
	3/4"	NL3/4"spss-254	20.0	39.0	3.2	2.14	100
M20		NL20ss-254	21.4	30.7	3.0	0.83	100
M20		NL20spss-254	21.4	39.0	3.2	1.98	100
M22	7/8"	NL22ss-254	23.4	34.5	3.2	1.19	100
M22	7/8"	NL22spss-254	23.4	42.0	3.2	2.44	50
M24		NL24ss-254	25.3	39.0	3.2	1.65	100
M24		NL24spss-254	25.3	48.5	4.5	4.47	50
	1"	NL1"ss-254	27.9	39.0	3.2	1.42	100
	1"	NL1"spss-254	27.9	48.5	5.6	5.30	50
M27		NL27ss-254	28.4	42.0	5.8	3.10	50
M27		NL27spss-254	28.4	48.5	5.8	5.34	25
M30	1 1/8"	NL30ss-254	31.4	47.0	5.8	4.04	50
M33	1 1/4"	NL33ss-254	34.4	48.5	5.8	3.86	25
M36	1 3/8"	NL36ss-254	37.4	55.0	5.8	5.50	25
M39	1 1/2"	NL39ss-254	40.4	58.5	5.8	6.74	25

ALLOY C-276

ORIGINAL WASHERS

DIMENSIONS

Surface hardened EN 2.4819
or equivalent

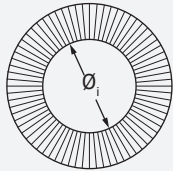

NL4ss-276
-NL8spss-276
 $\text{Ø}_i \pm 0.1 \text{ mm}$
NL10ss-276
-NL20ss-276
 $\text{Ø}_i \pm 0.2 \text{ mm}$

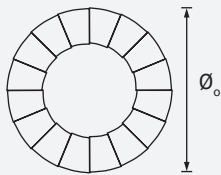

NL4ss-276
-NL20ss-276
 $\text{Ø}_o \pm 0.2 \text{ mm}$

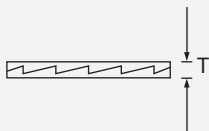

NL4ss-276
-NL12ss-276
 $T \pm 0.4 \text{ mm}$
NL12spss-276
-NL20ss-276
 $T \pm 0.5 \text{ mm}$

Bolt size	Product designation		Ø_i [mm]	Ø_o [mm]	Thickness T [mm]	Approx. weight kg/100 pairs	Min. Package [pairs]
	Metric	UNC					
M4	#8	NL4ss-276	4.4	7.6	2.3	0.043	200
M5	#10	NL5ss-276	5.4	9.0	2.3	0.059	200
M6		NL6ss-276	6.5	10.8	2.3	0.085	200
M8	5/16"	NL8ss-276	8.7	13.5	2.3	0.116	200
M8	5/16"	NL8spss-276	8.7	16.6	2.3	0.220	200
M10		NL10ss-276	10.7	16.6	2.3	0.175	200
M10		NL10spss-276	10.7	21.0	2.3	0.372	200
M12		NL12ss-276	13.0	19.5	2.3	0.230	200
M12		NL12spss-276	13.0	25.4	3.0	0.820	100
M16	5/8"	NL16ss-276	17.0	25.4	3.0	0.695	100
M20		NL20ss-276	21.4	30.7	3.0	0.820	100

Washers made from Alloy C-276 are extremely corrosion resistant and are perfect for use in situations that demand protection from aggressive corrosion and localized corrosion attack. Therefore they are very suitable for use in chemical plants. Important features of this washer include its resistance to oxidizers such as:

- Ferric and cupric chlorides
- Organic and inorganic hot contaminated media
- Chlorine (wet chlorine gas)
- Acids
- Hypochlorite
- Chlorine dioxide

ALLOY 718

ORIGINAL WASHERS

DIMENSIONS

Surface hardened EN 2.4668
or equivalent

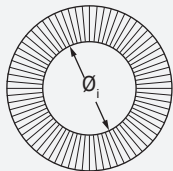

NL4ss-718
-NL8spss-718
 $\text{Ø}_i \pm 0.1 \text{ mm}$
NL3/8"ss-718
-NL20ss-718
 $\text{Ø}_i \pm 0.2 \text{ mm}$

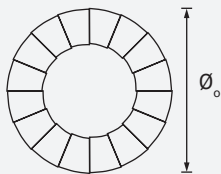

NL4ss-718
-NL20ss-718
 $\text{Ø}_o \pm 0.2 \text{ mm}$

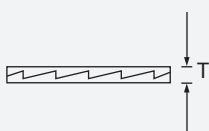

NL4ss-718
-NL12ss-718
(+ NL1/2"ss)
 $T \pm 0.4 \text{ mm}$
NL12spss-718
-NL20ss-718
 $T \pm 0.5 \text{ mm}$

Bolt size	Product designation		Ø_i [mm]	Ø_o [mm]	Thickness T [mm]	Approx. weight kg/100 pairs	Min. Package [pairs]
	Metric	UNC					
M4	#8	NL4ss-718	4.4	7.6	2.3	0.043	200
M5	#10	NL5ss-718	5.4	9.0	2.3	0.059	200
M6		NL6ss-718	6.5	10.8	2.3	0.085	200
	1/4"	NL1/4"ss-718	7.2	11.5	2.3	0.092	200
M8	5/16"	NL8ss-718	8.7	13.5	2.3	0.120	200
M8	5/16"	NL8spss-718	8.7	16.6	2.3	0.220	200
	3/8"	NL3/8"ss-718	10.3	16.6	2.3	0.190	200
M10		NL10ss-718	10.7	16.6	2.3	0.175	200
M10		NL10spss-718	10.7	21.0	2.3	0.372	200
M12		NL12ss-718	13.0	19.5	2.3	0.230	200
M12		NL12spss-718	13.0	25.4	3.2	0.820	100
	1/2"	NL1/2"ss-718	13.5	19.5	2.3	0.238	200
M16	5/8"	NL16ss-718	17.0	25.4	3.2	0.679	100
	3/4"	NL3/4"ss-718	20.0	30.7	3.2	0.956	100
M20		NL20ss-718	21.4	30.7	3.2	0.820	100

Washers made from Alloy 718 have exceptional high yield, tensile and creep-rupture properties at elevated temperatures, as well as corrosion resistance. Therefore these washers are the best choice for high temperature applications including:

- Jet engines
- Gas turbines
- Nuclear reactors
- Pumps

X-SERIES WASHERS

DIMENSIONS

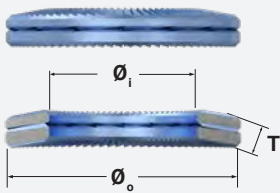

NLX6sp–NLX20
Ø₁ ±0.2 mm

NLX6sp–NLX20
Ø₀ ±0.2 mm

NLX6sp–NLX16sp
T +0.0/-0.2 mm

NLX3/4"–NLX20
T +0.0/-0.2 mm

Bolt size		Product designation	Ø ₁ [mm]	Ø ₀ [mm]	Thickness T [mm]	Approx. weight kg/100 pairs	Min. Package [pairs]
Metric	UNC						
M6		NLX6	6.3	10.8	1.90	0.08	200
M6		NLX6sp	6.3	13.5	2.00	0.16	200
M8	5/16"	NLX8	8.4	13.5	2.20	0.14	200
M8	5/16"	NLX8sp	8.4	16.6	2.20	0.25	200
	3/8"	NLX3/8"	10.0	16.6	2.60	0.26	200
M10		NLX10	10.5	16.6	2.80	0.27	200
M10		NLX10sp	10.5	21.0	3.30	0.62	200
M12		NLX12	12.5	19.5	3.40	0.43	200
M12		NLX12sp	12.5	25.4	4.00	1.12	100
	1/2"	NLX1/2"	13.2	19.5	3.50	0.41	200
M14	9/16"	NLX14	14.6	23.0	3.90	0.70	100
M16	5/8"	NLX16	16.6	25.4	4.60	0.98	100
M16	5/8"	NLX16sp	16.6	30.7	4.60	1.78	100
	3/4"	NLX3/4"	19.8	30.7	5.50	1.70	100
M20		NLX20	20.7	30.7	5.90	1.70	100

- In order to assure the unique mechanical locking function of Nord-Lock X-Series washers, the hardness of the mating surfaces must be lower than the hardness of the Nord-Lock X-Series washers.

Material standard	Hardening	Coating	Corrosion resistance	Temperature range
Steel EN 1.7225	Through hardened	Base coat: Delta Protekt® KL100 zinc flake coating Top coat: VH 302 GZ	Minimum 1,000 hours in salt spray test (according to ISO 9227)	-40°C to 150°C

WHEEL NUTS

DIMENSIONS

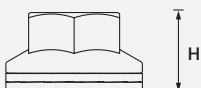
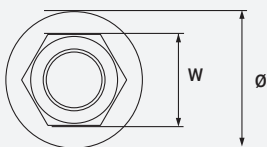

Thread	Product designation	Width W [mm]	Ø [mm]	Height H [mm]	Tightening torque Metric [Nm]	UNC [ftlb]	Clamp load Metric [kN]	UNC [lb]
M16x1.5	NLWN M16	24.0	34.5	23.0	280	205	~100	~22,500
M18x1.5	NLWN M18	27.0	40.0	24.0	400	295	~130	~29,200
M20x1.5	NLWN M20	30.0	45.0	26.0	550	405	~160	~36,000
M22x1.5	NLWN M22	32.0	46.0	27.0	650	480	~180	~40,500
7/8"-11 BSF	NLWN 7/8"-11	32.0	46.0	27.0	650	480	~170	~38,200
M24x1.5	NLWN M24	36.0	48.0	33.0	950	700	~240	~54,000

Coating	Corrosion resistance	Lubrication	Property class
Base coat: Delta Protekt® KL100 zinc flake coating Top coat: VH 302 GZ	Minimum 600 hours in salt spray test (according to ISO 9227)	Anti-corrosive wax Dry film lubricant/ lubricating paste	Class 10

SC-WASHERS

DIMENSIONS

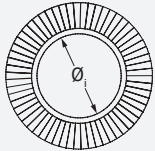

NL12SC–NL16SC
 $\text{Ø}_i +0.17/-0.1 \text{ mm}$
 NL20SC–NL36SC
 $\text{Ø}_i \pm 0.2 \text{ mm}$

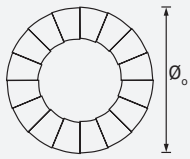

NL12SC–NL16SC
 $\text{Ø}_o +0.3/-0.2 \text{ mm}$
 NL20SC–NL24SC
 $\text{Ø}_o \pm 0.3 \text{ mm}$
 NL27SC
 $\text{Ø}_o \pm 0.5 \text{ mm}$
 NL30SC–NL36SC
 $\text{Ø}_o \pm 0.6 \text{ mm}$

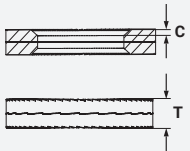

NL12SC–NL30SC
 $T \pm 0.25 \text{ mm}$
 NL36SC
 $T \pm 0.6 \text{ mm}$

Bolt size		Product designation	Ø_i [mm]	Ø_o [mm]	Thickness T [mm]	Chamfer C [mm]	Approx. weight kg/100 pairs	Min. Package [pairs]
Metric	UNC							
M12		NL12SC	13.1	23.7	4.6	1.2	1.0	100
M16	5/8"	NL16SC	17.1	29.7	4.6	1.2	1.5	100
M20		NL20SC	21.4	36.7	4.6	1.5	2.3	100
M22	7/8"	NL22SC	23.4	38.7	4.6	1.5	2.5	50
M24		NL24SC	25.3	43.7	4.6	1.5	3.2	50
M27		NL27SC	28.4	49.5	5.8	1.8	5.6	25
M30	1 1/8"	NL30SC	31.4	55.4	5.8	1.8	6.9	25
M36	1 3/8"	NL36SC	37.4	65.4	6.0	1.6	11.0	25

Material standard	Hardening	Coating	Corrosion resistance	Temperature range
Steel EN 1.7182	Through hardened	Delta Protekt® KL100 zinc flake coating	Minimum 1,000 hours in salt spray test (according to ISO 9227)	-40°C to 150°C

- Torque guidelines:
 Web app: torquelator.nord-lock.com
www.nord-lock.com/torque
- 2D/3D CAD models:
www.nord-lock.com/cad

NEED A CUSTOM SOLUTION FOR A UNIQUE CHALLENGE?

If you cannot find the washers you are looking for in our standard range, we will be happy to customize a solution for you. Simply select your preferred dimensions, material and coating, and we will create the perfect washers for your application.

Possible customization options:

- Coatings with improved corrosion resistance
- Colored coatings
- Custom inner and outer diameter
- Left-handed washers
- Custom thickness
- Custom materials
- Added chamfers
- Customer-unique laser marking

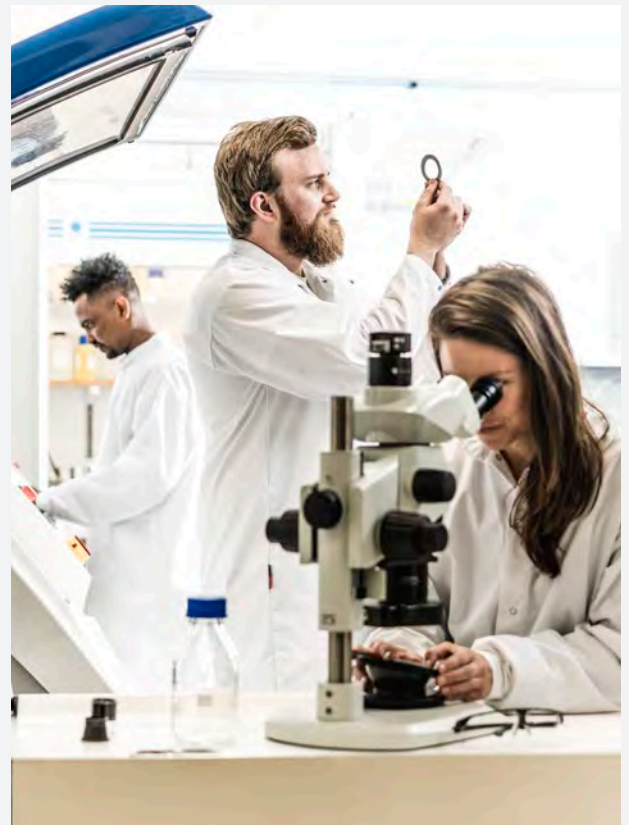

WHEN SAFETY REALLY MATTERS

Whatever the clamp load, environment or extent of vibration on your application, we will work together to optimize safety and minimize maintenance.

Over 35 years of experience in the world's diverse industries has given us unprecedented expertise in bolted connections.

No matter what your bolting or engineering challenge is – Nord-Lock has the perfect solution for you.



00002ENS - 2020-09_V2

AUTHORISED DISTRIBUTOR



HOBSON ENGINEERING
10 Clay Place, Eastern Creek NSW 2766
(02) 8818 0222
www.hobson.com.au